

SIMULATION OF THE COLD FORGING PROCESS IN FASTENER MANUFACTURE

Umut İnce^a , Mustafa Güden^b

^aNorm Fasteners Cooperation 35620 Çiğli, İzmir, Turkey

^b Department of Mechanical Engineering and Dynamic Testing and Modeling Laboratory, Izmir Institute of Technology, Gülbahçe, Urla, Izmir, Turkey

Abstract

The use of finite element method increasingly as tool in metal forming industry result in cost reduction, time saving and improvement in product quality. The simulation software in the cold forging industry show material flow, capture the defects and allow to determine the process parameters such as pres forces, die stresses, predict the tool life and fracture and calculate residual stresses. The present study reports two case studies of the cold forging simulation in fastener production.

Introduction

The recent continuing progresses in the software development, computer powers and finite element analysis have led to 2D and 3D simulations of the entire cold forging processes including cold forging fastener production. The fastener production is in fact an intricate process comprising the sequences and combinations of the forming processes such as pre-heading, heading, forward and backward extrusions and trimming. There have been numerous studies in the literature on the modeling of the cold forging forming processes; noting that new approaches in the theoretical background of both finite element analysis and cold forging processes have appeared particularly after the year of 2000. McCormac et.al [1-2] conducted 2D and 3D finite element analysis of three stage cold forging sequence and the cold forging dies, showing well agreements with the experimental results. Yeo et.al [3] analyzed and designed the pre-stressed cold forging dies and proposed a methodology of increasing the die lives. A new code was developed by Saniee et.al [4] to determine the cold forging loads and the axial stress distribution in the closed die forging of round parts.

It is well known that the quality of the simulations based on the finite element analysis results is highly related with the use of reliable process input-data of the simulated processes and the material properties. A guide of validation of finite element simulations in the bulk metal forming processes has been reported by Tekkaya [5]. The validations of numerical simulations are virtually based on the comparisons of modeling results with those of the forming processes. Once the model is validated, it becomes a very powerful tool, not only in the designing stage of forming process but also in the identification of the operating faulty designs. The numerical simulation tools in the design and production stages of the forming processes have been extensively used by Norm Fasteners Cooperation (NFC) since 2003 to simulate the cold forging metal processes. Catia V5 and Mechanical Desktop 6 software are used for 2D and 3D modeling and Simufact SFM 8.0 for performing simulations. The present study reports two different examples of the applications of the finite element analysis in the cold forging processes used to produce fasteners.

Case Study 1: Lap Formation and Forging Loads

A standard hexagon head bolt shown in Figure 1 is produced in two-station by a cold forging mechanical press. An initial 3D model and the forging sequences are shown in Figure 2. The forging sequence was simulated using 2D axisymmetrical and 3D models. Since the hexagon head is not axisymmetrical, it is represented in axisymmetrical model with the cylindrical form having the same effective area with hexagon head as shown in Figure 3. The performed 2D axisymmetrical and 3D simulations of the initially designed forging processes resulted in the lap formations during the forming process. Figure 4(a) and (b) show the lap formation in 2D and Figure 4(c) and (d) in 3D simulations.

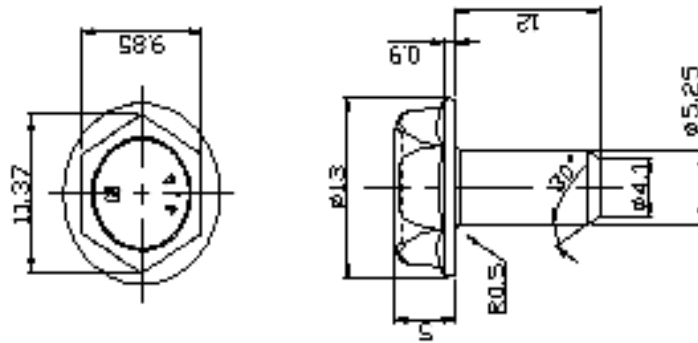

Figure 1 A standard hexagon bolt dimensions.

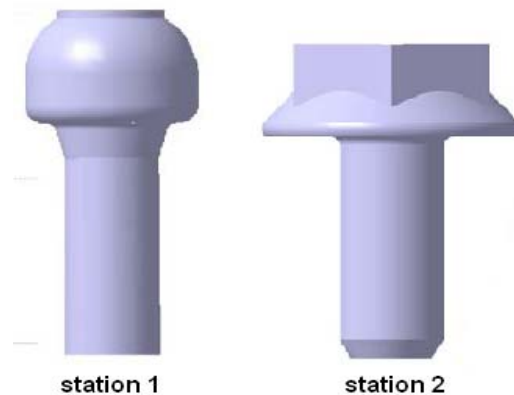

Figure 2 Initial 3D models of the bolt design with two-station forging sequence.

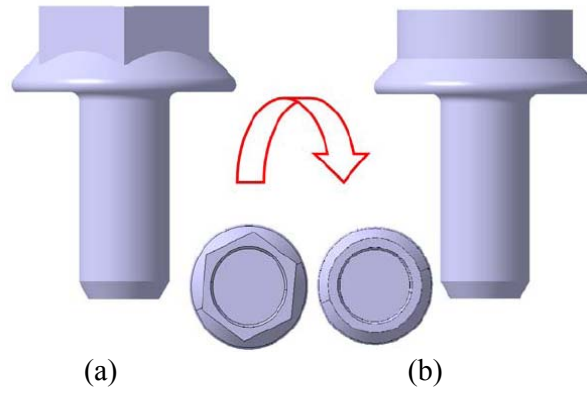
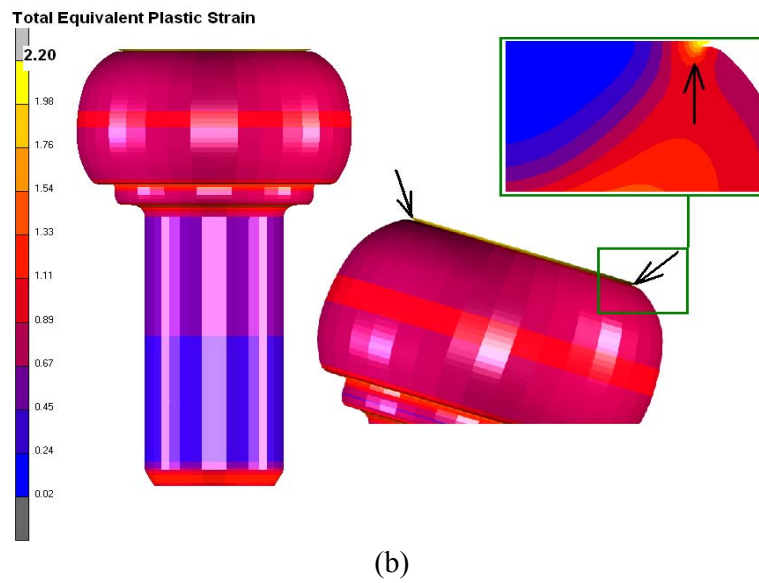
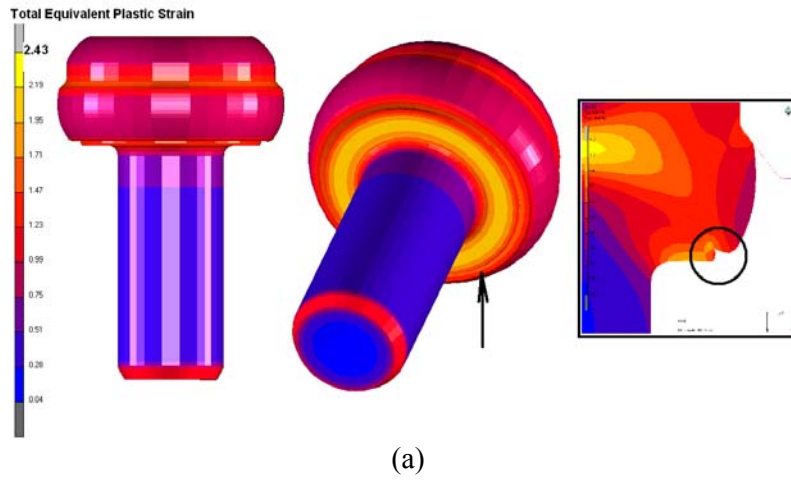

Figure 3 2D axisymmetrical model representation of 3D model of (a) hexagon head with (b) the cylindrical form of the same effective area.



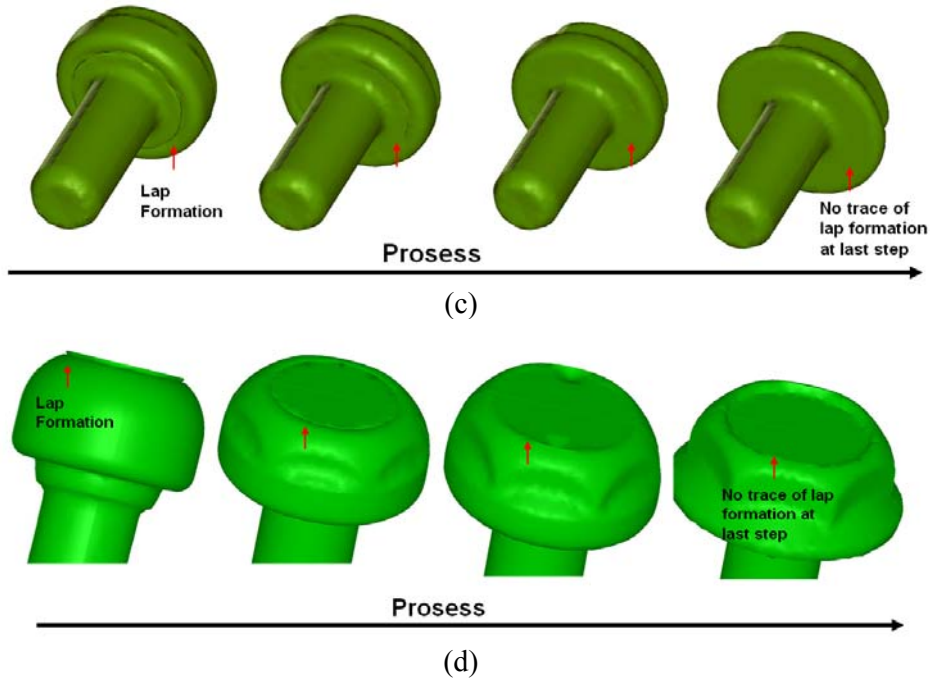

Figure 4 Lap formations detected on the head of fastener during (a – b) 2D axisymmetrical (c – d) 3D simulations.

The bolt produced with the above forging sequence was sectioned and polished in order to observe the lab formation microscopically. It should be noted here that after the cold forging it is very difficult to determine the laps visually form the surface of bolt. In Figure 5, two lab formations, at the upper and the lower section of the hexagon head in the polished sections of the hexagon head are shown. The places of the lab formation show good correlations with those of the models. These results confirmed that numerical simulation method is very useful tool in order to determine the faulty designs in the cold forging sequence.

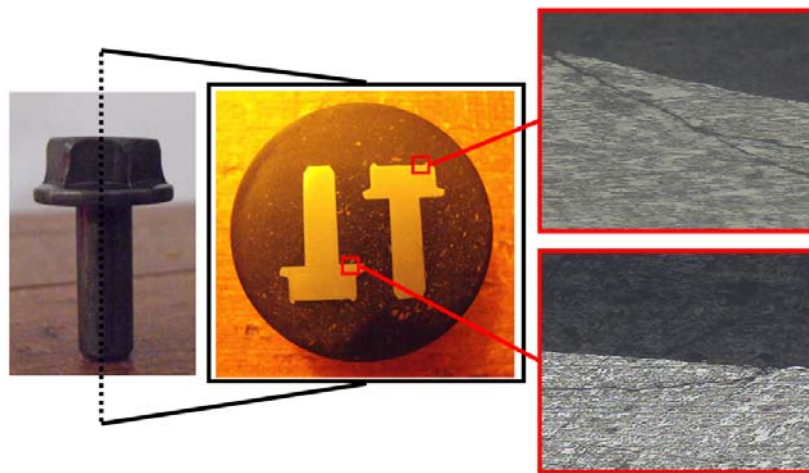

Figure 5 Microscopically determined laps on the bolt produced with the design given in Figure 2.

A modified cold forging sequence was simulated to prevent the lap formation by changing the deformation sequence as depicted in Figure 6. The deformation simulations from 1st station to final shape of the modified deformation sequence are shown in Figure 7. No lap formation is detected in the model and the cold forging loads of 2D axisymmetrical and 3D simulations are also highly comparable.

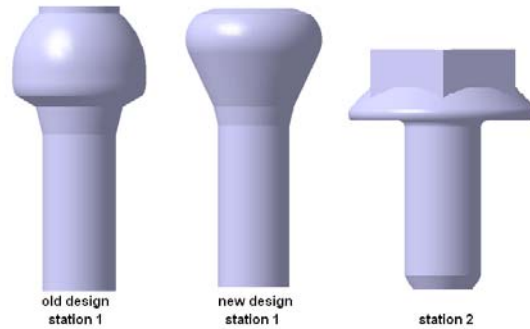

Figure 6 3D models of the initial and modified deformation sequences.

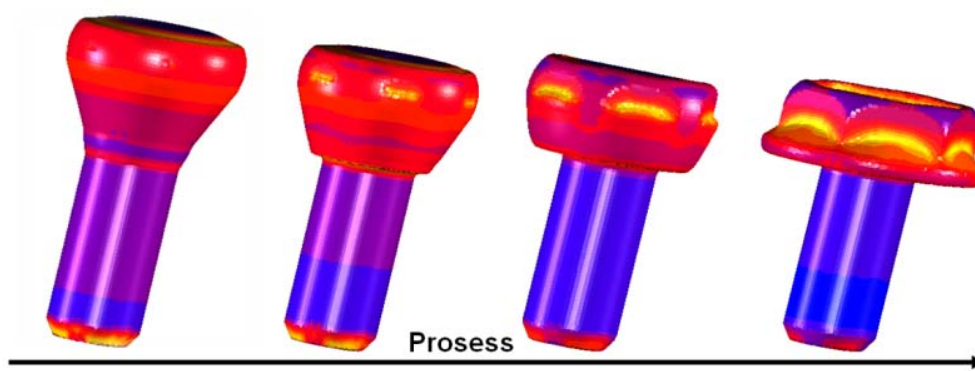

Figure 7 3D simulations of the modified cold forging sequence in the 2nd station.

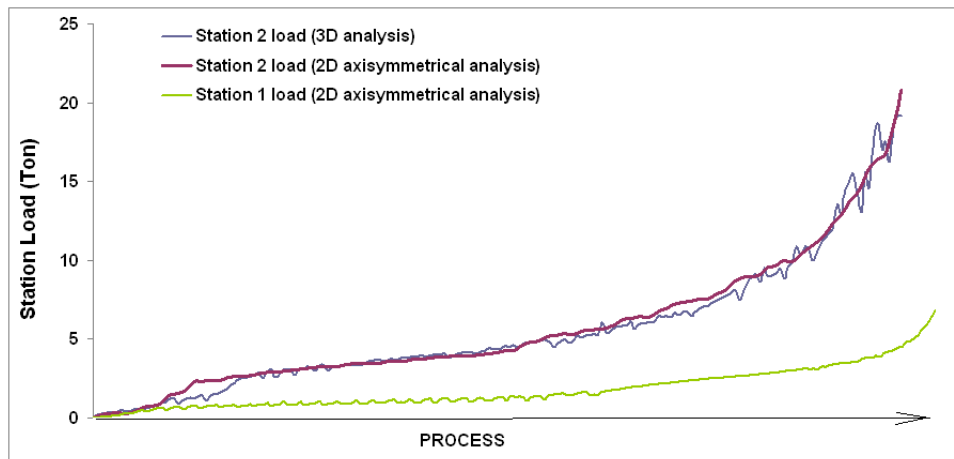
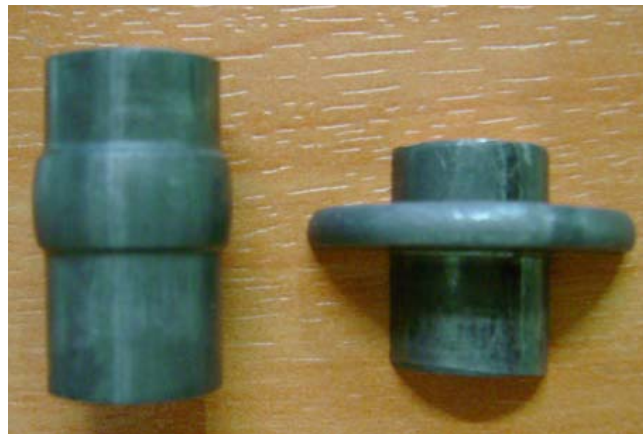

Figure 8 Forging Loads for station 1 and station 2 calculated with 2D axisymmetrical, and 3D simulation.

Case Study 2: Cold Forging Die Stress Analysis and Optimization

In a fastener cold forging sequence shown in Figure 8(a) and (b), the punch die of the 2nd station was observed to fail after about 10000 cycles. In order to identify the possible reasons for the die failure, the forging sequence was simulated using a deformable punch die material model. Materials boundary and fitting conditions used in the simulation were the same with the forging process. 2D axisymmetrical model was used for all simulations. The model results are shown in Figure 9. A high value of negative principle stress is clearly seen at the top surface of the insert as shown by the circles in Figure 9. This stress is found to be responsible for the failure of the die.



(a)

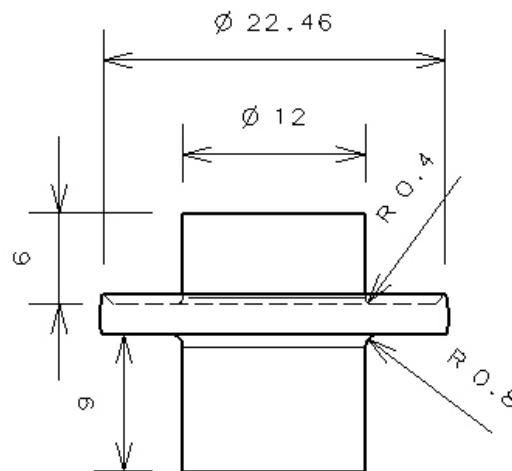

(b)

Figure 8 (a) Cold forging sequence and (b) the final dimension of the fastener

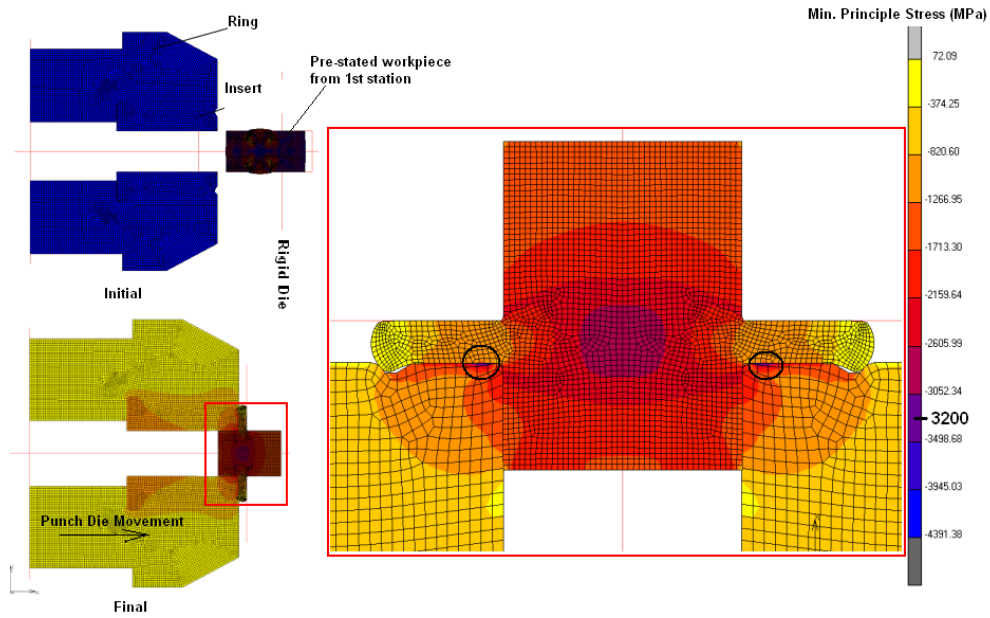

Figure 9 Deformable die model and high value of principle stresses at the top surface of the insert.

Initially the insert material type and the punch die geometry were changed. These modifications resulted in die stress values changing only with slightly. Following modifications were made to reduce the die stress values. First, the fastener was reversed so that top surface of punch die insert compress less material and the die design was modified accordingly as shown in Figure 10. The modeling results with the modifications are shown in Figure 11. The model gave an acceptable negative principal stress value (2300 MPa) for WC/Co tool steel dies.

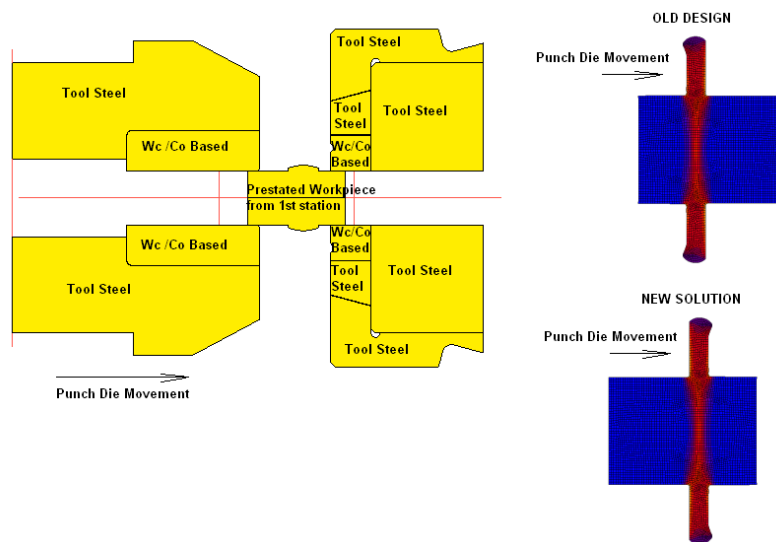

Figure 10 Reversed design of the fastener and the modified dies.

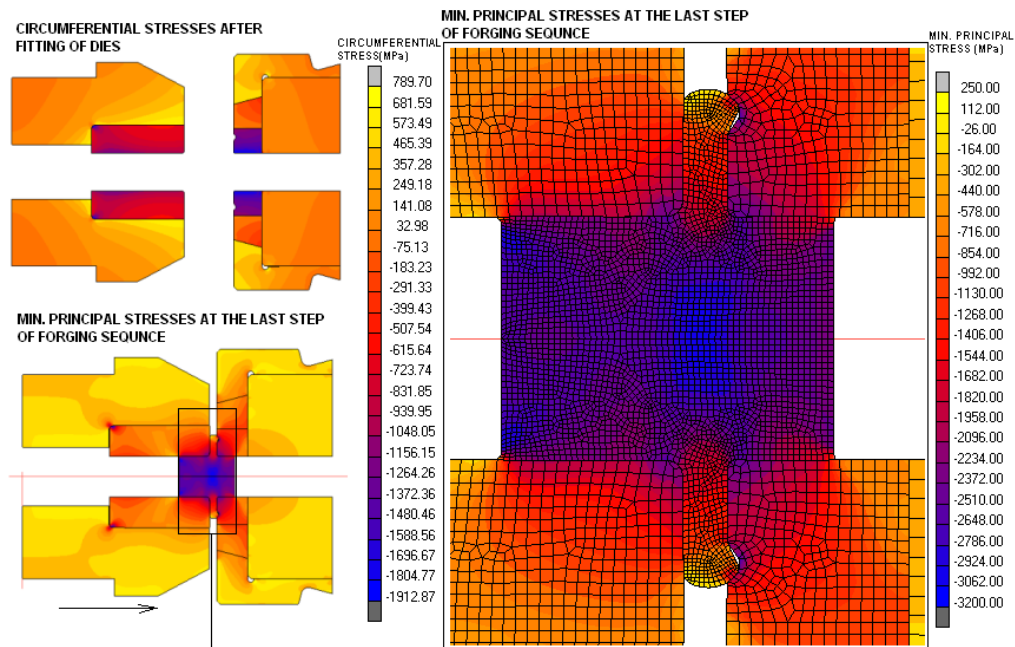

Figure 11 Circumferential stresses after fitting of dies before forging and the minimum principle stresses at the last step of the forging sequence.

Conclusion

The use of finite element method as tool in metal forming industry results in cost reduction, time saving and improvement in product quality. The design of deformation sequence and dies could be modeled before and also during the production. These efforts allow the engineer to identify the process deficiencies easily, leading to cost and time saving. The modeling efforts would be very valuable in order to verify inhomogeneous deformations such as laps which could not be detected easily through regular visual inspection

References

1. McCormack C., Monagan J. A, A finite element of analysis of cold forging dies using two and three dimensional model. Journal of material processing technology Vol.118 2001, P. 286-292.
2. McCormack C., Monagan J. A, 2D and 3D finite element analysis of a three stage forging sequence. Journal of material processing technology Vol. 127, 2002, P. 48-56.
3. Yeo H. T., Choi Y, and Hur K. D. Analysis and Design of the Prestressed Cold Extrusion Die. Int J Adv Manuf Technol, Vol 18, 2001, P. 54-61.
4. Fereshteh-Saniee F., Jaafari M. Analytical, numerical and experimental analysis of closed die forging, Journal of Material Processing Technology, Vol. 125-126, 2002, P. 334-340.
5. A. Erman Tekkaya, A guide for validation of FE simulations in bulk metal forming. The Arabian Journal for Science and Engineering, Vol 30, 2005, P. 113-136.